

▲ WARNING Failure to read and follow the operator's manual and all operating instructions could result in death, serious injury, and/or property damage.

▲ WARNING Fuel and its vapors are extremely flammable and explosive which could cause burns, fire or explosion resulting in death, serious injury and/or property damage. Turn pressure washer engine OFF and let it cool at least 2 minutes before removing fuel cap. Let spilled fuel evaporate before starting engine. Always allow space for fuel expansion.

▲ WARNING Starter cord kickback (rapid retraction) will pull hand and arm toward engine faster than you can let go which could cause broken bones, fractures, bruises, or sprains resulting in serious injury. NEVER pull starter cord without first relieving spray gun pressure. Pull starter cord slowly until resistance is felt, then pull rapidly. Firmly grasp spray gun with both hands when using high pressure spray to avoid injury when spray gun kicks back.

▲ WARNING Engine exhaust contains carbon monoxide, a poisonous gas that could kill you in minutes. You CANNOT smell it, see it, or taste it. Operate ONLY outside far away from windows, doors and vents. Install carbon monoxide alarms. DO NOT run this product inside homes or garages, even if using fans or opening doors and windows.

▲ WARNING High water pressure could cut through skin resulting in serious injury. Spray gun traps high water pressure, even when engine is stopped and water is disconnected. NEVER aim spray gun at people, animals, or plants. ALWAYS point spray gun in safe direction, press red button and squeeze spray gun trigger to release high pressure, every time you stop engine.

▲ WARNING Risk of eye injury. Spray could splash back or propel objects resulting in serious injury. Always wear indirect vented (chemical splash) safety goggles marked to comply with AS/NZS 1337 (ANSI Z87.1 equivalent) when using or in vicinity of this equipment. NEVER substitute safety glasses or dry-condition goggles for indirect vented safety goggles.

Items Included:

Operator's Manual (not shown)

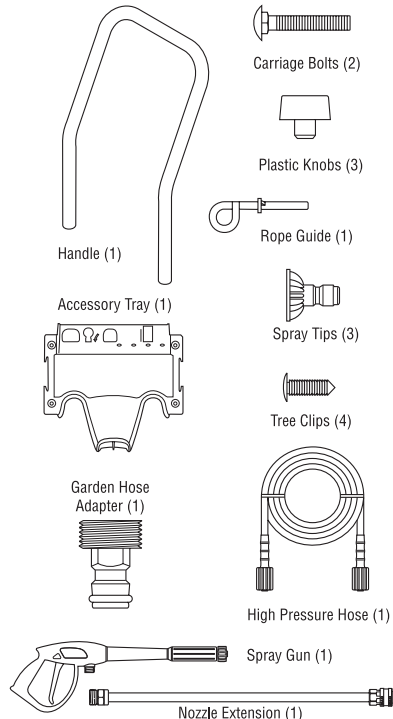

You will need

- Utility knife
- Unleaded fuel
- Engine oil
- Garden hose, 15m (50 ft.) or less
- Safety goggles (indirect vented type)

Unpack pressure washer

1. Remove everything from carton except pressure washer.
2. Open carton completely by cutting each corner from top to bottom.
3. Ensure you have all included items prior to assembly. If items are damaged or missing, call 1-300-BRIGGS (274.447).
4. Prior to assembly, lubricate all o-ring connections as described in operator's manual.

Assemble pressure washer

1. Place handle (A) onto handle supports (B) connected to main unit. Make sure holes (C) in handle align with holes (C) on handle supports. ①
- NOTICE** It may be necessary to move the handle supports from side to side in order to align the handle so it will slide over the handle supports.
2. Insert carriage bolts (D) through holes from back of unit and attach a plastic knob (E) from front of unit. Tighten by hand. ②
3. Attach rope guide (F) through handle with plastic knob (G). Tighten by hand. Route engine recoil rope through guide. ③
4. Place accessory tray (H) over holes on handle (J) (viewing from front of unit). Push four tree clips (K) into the holes until they sit flat against the accessory tray. ④
5. Insert multi-colored spray tips and other supplied accessories in spaces provided in accessory tray. See *How to Use Accessory Tray*, in operator's manual.

Add engine oil and fuel

NOTICE You MUST properly fill engine with oil before attempting to start pressure washer.

NOTICE DO NOT use E85 fuel.

NOTICE DO NOT mix oil with fuel.

1. Move pressure washer outdoors to a flat, level surface.
2. Clean area around oil fill and remove oil fill cap/dipstick (⑤).
3. Using oil funnel (optional), slowly pour engine oil into oil fill opening. Pause to permit oil to settle. Fill to FULL mark (top hole) on dipstick.

NOTICE Wipe dipstick clean each time oil level is checked. DO NOT overfill.

4. Replace and tighten dipstick.
5. Clean area around the fuel cap (⑥), remove fuel cap. ⑤

6. Slowly add regular unleaded fuel (L) to fuel tank (M). Be careful not to overfill. Allow about 4 cm (1.5 in.) (N) of tank space for fuel expansion. ⑥

7. Install fuel cap and let any spilled fuel evaporate before starting engine.

①

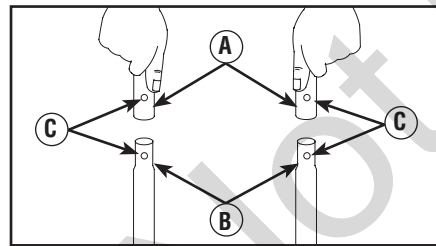

②

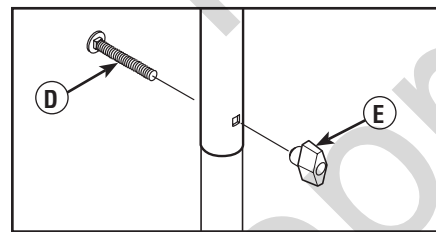

③

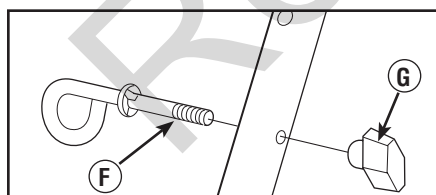

④

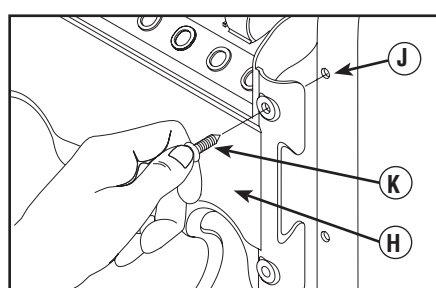

⑤

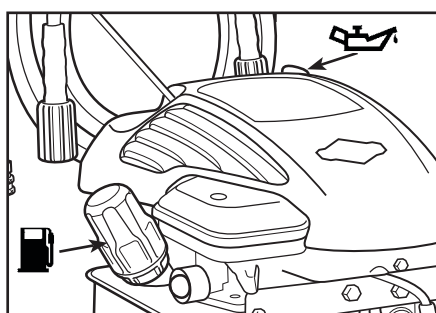

⑥

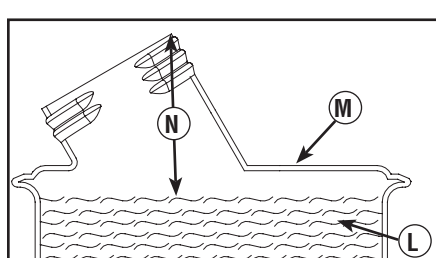

Move pressure washer to safe operating location

▲ WARNING Engine exhaust contains carbon monoxide, a poisonous gas that could kill you in minutes. You CANNOT smell it, see it, or taste it. Operate ONLY outside far away from windows, doors and vents. Install carbon monoxide alarms. DO NOT run this product inside homes or garages, even if using fans or opening doors and windows.

1. Move pressure washer outside to a flat, level surface. ⑦
2. Keep at least 1.5 m (5 ft.) clearance on all sides of pressure washer including overhead to reduce the risk of exhaust heat or exhaust gases igniting nearby combustible material.

⑦

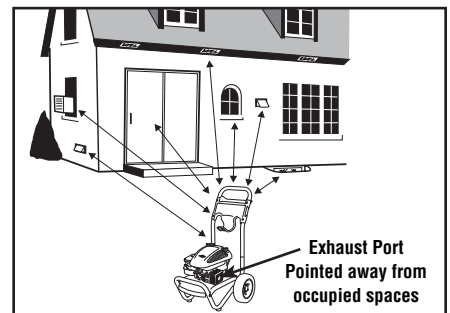

Connect spray gun

NOTICE Remove and discard the shipping caps from the pump's high pressure outlet and water inlet before attaching hoses.

1. Uncoil high pressure hose (P) and attach one end of hose to base of spray gun (Q). Tighten by hand. ⑧
2. Attach other end of high pressure hose (P) to high pressure outlet (R) on pump. Tighten by hand. ⑨

⑧

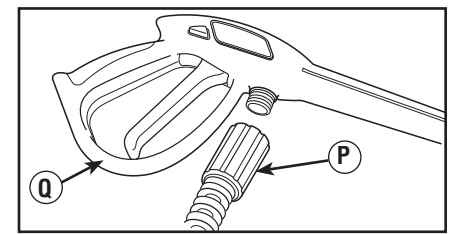

⑨

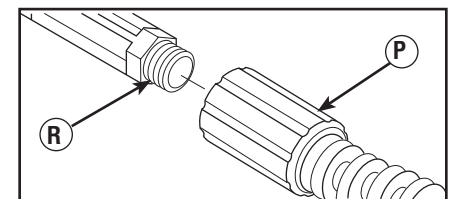

Connect water supply

1. Inspect garden hose inlet screen (S) for damage. ⑩

NOTICE If inlet screen is damaged or missing, DO NOT use pressure washer, call 1-300-BRIGGS (274.447).

2. Clean screen if it contains debris or have it replaced if damaged.
3. Attach garden hose adapter (T) to water inlet (U). Tighten by hand. ⑩
4. Run cold water through garden hose (V) for 30 seconds to clean out any debris. Garden hose length must not exceed 15 m (50 ft.).
5. Turn off water supply and attach garden hose to water inlet. Pull back on collar of quick connect, slide fitting onto water inlet and let go of collar. Pull on garden hose to be sure of a tight connection. ⑩

⑩

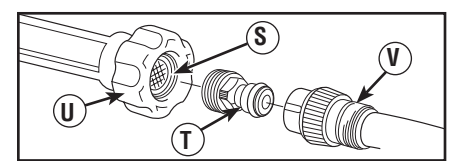

Start pressure washer

NOTICE You MUST connect and turn on water supply fully before starting engine.

1. Turn on water supply.
2. Put on safety goggles.

⑪

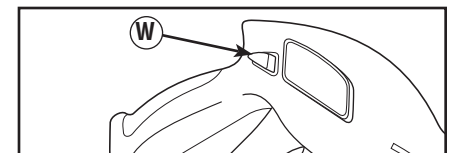

▲ WARNING Risk of eye injury. Spray could splash back or propel objects resulting in serious injury. Always wear indirect vented (chemical splash) safety goggles marked to comply with AS/NZS 1337 (ANSI Z87.1 equivalent) when using or in vicinity of this equipment. NEVER substitute safety glasses or dry-condition goggles for indirect vented safety goggles.

3. Point gun in a safe direction and press red safety button (W) on spray gun and pull trigger until water comes out in a steady stream. ⑪
4. Attach nozzle extension (X) to spray gun (Q). Tighten by hand. ⑫
5. Choose desired quick-connect spray tip (Y), pull back on collar of nozzle extension (X), insert spray tip and release collar. Tug on spray tip to make sure it is securely in place. ⑬
6. Move throttle lever (Z) to "Fast" (🐰) position, shown here as a rabbit. ⑭
7. To start the engine for the very first time. Push primer bulb (AA) firmly 5 times, waiting 2 seconds between each push. ⑮
8. When starting engine, position yourself as recommended. Grasp starter grip handle and pull slowly until you feel some resistance. Then pull rapidly to start engine. ⑯

⑫

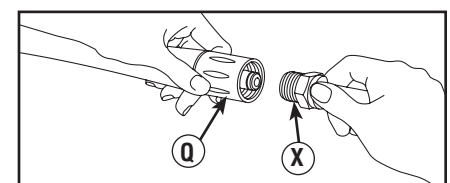

⑬

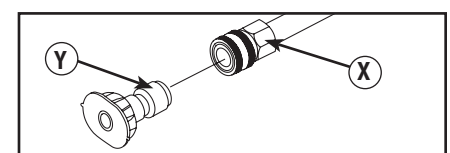

⑭

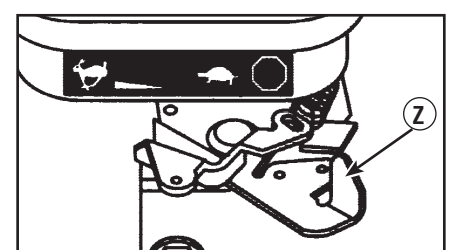

⑮

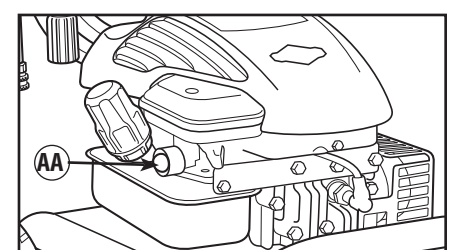

▲ WARNING Starter cord kickback (rapid retraction) will pull hand and arm toward engine faster than you can let go which could cause broken bones, fractures, bruises, or sprains resulting in serious injury. NEVER pull starter cord without first relieving spray gun pressure. Pull starter cord slowly until resistance is felt, then pull rapidly. Firmly grasp spray gun with both hands when using high pressure spray to avoid injury when spray gun kicks back.

9. After each starting attempt, where engine fails to run, always point gun in safe direction press red safety button and squeeze spray gun trigger to release high pressure.

NOTICE Always keep the throttle lever in the "Fast" (🐰) position when operating the pressure washer.

10. Point gun toward surface to be cleaned. Press red safety button and pull trigger to begin spraying.

Stop pressure washer

1. Release spray gun trigger and let engine idle for two minutes.
2. Move throttle to SLOW (🐌) position, then STOP (🛑) position. ⑯
3. Turn off water supply.
4. Point spray gun in safe direction, press red safety button, and squeeze spray gun trigger to relieve retained high water pressure.

NOTICE Spray gun traps high water pressure, even when engine is stopped and water is disconnected.

5. Disconnect garden hose from pump.
6. Disconnect high pressure hose from pump and gun for storage. For long term storage instructions, see operator's manual.
7. Remove safety goggles.

⑯

